



KRENDL

#309 BLOWER



Known for durability and high production, our blower is designed with a hard coated fan and a steel chamber, powered by a rugged Dumore motor with manual thermal overload protection. This blower is designed to blow cellulose insulation fibers that are properly conditioned by agitation in the hopper. The high speed (13,000 r.p.m.) conditioning effect of the blower fan provides unsurpassed performance in sidewall blowing and coverage in open attic blowing.

MATERIAL PRODUCTION RATE

lbs/hr (kg/hr) rating with 100ft. (30.5m.) of 2 1/2" (6.4cm.) hose at 10ft. (3.1m.) elevation

MATERIAL	SMALL FAN 6 1/2" (16.5 cm)	MEDIUM FAN 7 1/2" (19.1 cm)
CELLULOSE	800 lbs/hr (363 kg/hr)	1000 lbs/hr (454 kg/hr)

Note: All hose connections must be securely clamped. Product density and variable blowing conditions will affect production rate.

FEATURES AND BENEFITS

- 2" (5.1cm.) or 2 1/2" (6.4cm.) output tube so that a hose adapter is no longer needed
- A hard coated, dynamically balanced aluminum/steel fan increases motor life
- Steel (11 gauge) fan chamber withstands abrasion and occasional debris which may enter unit
- Bolt-on zinc adapter attached to fan chamber allows for quick, easy replacement of connection exposed to wear
- Convenient carrying handle provides for easy handling and attachment to machine
- Combination cone/bracket switch guard eliminates damage to switch during handling
- Heavy duty triple sealed ball bearings provide a longer bearing life
- Manual thermal overload protection protects the blower from overheating and failure due to overload
- 2-pin "breaker" at inlet of fan pulverizes any lumps in the fiber
- Steel fan increases fan life / reduced brush and motor life



BLOWER SPECIFICATIONS

FANSIZE/TYPE	FAN DIAMETER	FAN CHAMBER	*AMPERAGE RANGE (amps) Closed Orifice Open Orifice	PRESSURE 1 BLOWER (p.s.i.)	PRESSURE 2 BLOWER IN-LINE (p.s.i.)	VOLUME (c.f.m)
small	6 1/2" (16.5 cm.)	9" (22.9 cm.)	11 - 17	1.75	3.0	160
medium	7 1/2" (19.1 cm.)	10" (25.4 cm.)	13 - 21	2.0	3.5	180

* Actual amperage of blower motor in normal running mode is closer to the **closed** orifice rating.

GENERAL SPECIFICATIONS

Amperage: 16.8 motor, 120volt/50/60hz
8.4 motor, 240volt/50/60hz

Motor: 1.5hp/16,500 r.p.m. (no load)

Weight: 30 lbs. (13 kg.)blower w/medium steel chamber,
2 1/2" (6.4cm.) output tube (other blower combinations weigh less) see reverse side for more information.

OPTIONS AVAILABLE

- fan/chamber (small or medium)
- chamber outlet size - 2" (5.1cm.) or 2 1/2" (6.4cm.)
- steel fan / increased amperage requirements / reduced brush and motor life

SMALL FAN

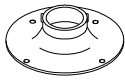

Small Fan Chamber
w/2" (5.1cm.) outlet
Part No: KBL-030-A-2

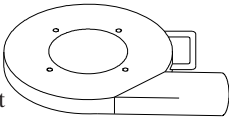

Small Fan Chamber
w/2 1/2" (6.4cm.) outlet
Part No: KBL-030-A-2.5

Small Aluminum Fan
Part No: KBL-028-A-AL

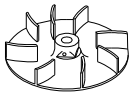

Small Steel Fan
Part No: KBL-028-A-STL

Small Backing Plate
Part No: KBL-026-A

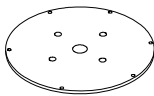

MEDIUM FAN



Zinc Male Adapter
Part No: KBL-033

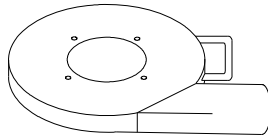

Medium Fan Chamber
w/2" (5.1cm.) outlet
Part No: KBL-030-B-2

Medium Fan Chamber
w/2 1/2" (6.4cm.) outlet
Part No: KBL-030-B-2.5

Medium Aluminum Fan
Part No: KBL-028-B-AL

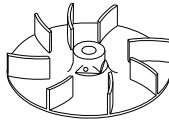

Medium Steel Fan
Part No: KBL-028-B-STL

Medium Backing Plate
Part No: KBL-026-B

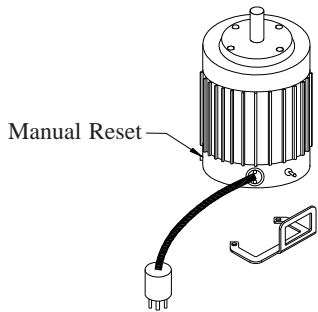
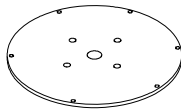

Manual Reset

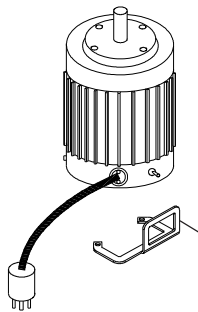

Bracket Switch Guard
Part No: KBL-042

MACHINE ADAPTERS

(for blower attachment to machine)

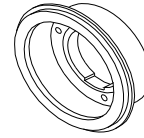

6" (15.2cm.) Collar
Part No: 112-CA

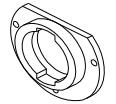

2 3/8" (6.0cm.) Adapter
Part No: 112-BA



2" (5.0cm.) Adapter
Part No: 112-AA

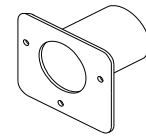

HOSE ADAPTER

(for attachment of multiple blower systems to intake of Zinc Male Adapter on blower)

Part No: 385 - 2" (5.1cm.) hose

Part No: 376 - 2 1/2" (6.4cm.) hose

An **In-line** Blower System provides the following benefits.

- 1.) Increased line pressure (p.s.i. nearly doubled) for dense compaction in retro-side wall blowing.
- 2.) Increased hose length and distance at which the material can be blown.

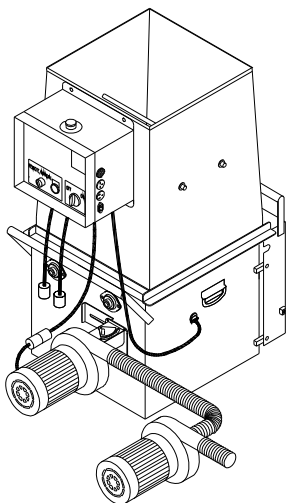

IN-LINE BLOWER SYSTEM

A **Parallel** Blower System provides the following benefits.

- 1.) Increased volume (c.f.m. nearly doubled) and velocity of air into delivery system.
- 2.) Increased production rate over the standard hose length. (100-150ft./30.5-45.8m.)

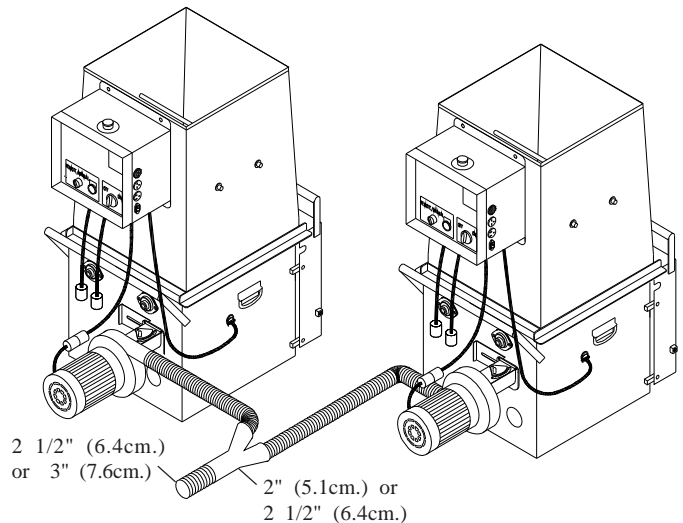

2 1/2" (6.4cm.)
or 3" (7.6cm.)

2" (5.1cm.) or
2 1/2" (6.4cm.)

PARALLEL BLOWER SYSTEM